

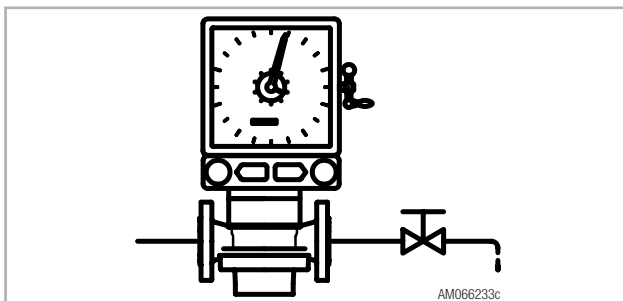

AS, ASP

Filling controllers

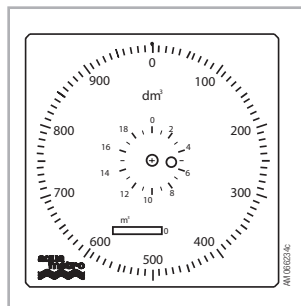
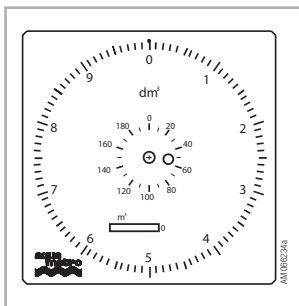

For manual or semi-automated filling/dosing controlling in explosion-risk or non explosion-risk zones (types AS and ASP). Ideal for filling/dosing at frequently changing rates.

Features

- System modification by retrofitting or replacing modules
- Suitable for all DOMINO flowmeters

Benefits

- Economic measuring point layout
- Customized solutions for each application
- Large legible scale
- Filling controller can be rotated on vertical axis to best reading and operating position

AS filling controllers

Technical data



- Manual filling control.
 - The filling sequence is started and stopped by operating a manual shut-off valve.
 - The filling reading is displayed on the resettable scale of the controller.
- The total quantity filled is recorded on a roll-type meter which cannot be reset.

Operating principle

Before starting the filling procedure, set the pointer and dial to zero by turning the reset knob on the side of the controller clockwise. Open the shut-off valve manually. The quantity which has passed through the flowmeter is clearly displayed on the scale. When the desired filling level is reached, close the shut-off valve manually and reset the pointer to zero with the knob.

The external scale is divided into 100 graduations. 20 turns of the large pointer correspond to 1 turn of the dial. The entire quantity filled is recorded on a 7-digit roll-type meter which cannot be reset.

Scale type	AS	11x	12x	13x
Temperature of medium inside meter	°C max.	180	180	180
Protection class		IP 65	IP 65	IP 65
Display scale				
Quantity per turn of large pointer	l	10	100	1000
Quantity per turn of small pointer	l	200	2000	20000
Smallest filling quantity approx. ¹⁾	l	3	25	250
Smallest readable quantity	l	0.1	1	10
Roller counter totalizer				
Registration capacity	Mio. m³	0.1	1	10
Smallest readable quantity	l	1	10	100
Weight				
AS 110, 120		kg	2.75	2.75 -
all other type		kg	3	3

¹⁾ Measuring tolerance is about 0.5 % of scale graduation due to mechanical clearances. For small quantities the percentage error is larger. Minimum filling quantity therefore depends entirely on desired filling precision. The values shown are recommended data.

Combination with DOMINO flowmeters

Version	Filling quantity up to ... litres	Flowmeter (type and nominal bore)										
		ARD					AMD		PMD			
		15	20	25	40	50	25	40	20	25	32	40
AS 110	200	-	-	●	●	-	●	●	●	●	●	●
AS 111	200	●	●	-	-	-	-	-	-	-	-	-
AS 120	2000	-	-	-	-	●	-	-	-	-	-	-
AS 121	2000	-	-	●	●	-	●	●	●	●	●	●
AS 122	2000	●	●	-	-	-	-	-	-	-	-	-
AS 131	20000	-	-	-	-	●	-	-	-	-	-	-
AS 132	20000	-	-	●	●	-	●	●	●	●	●	●
AS 133	20000	●	●	-	-	-	-	-	-	-	-	-

Dimensions

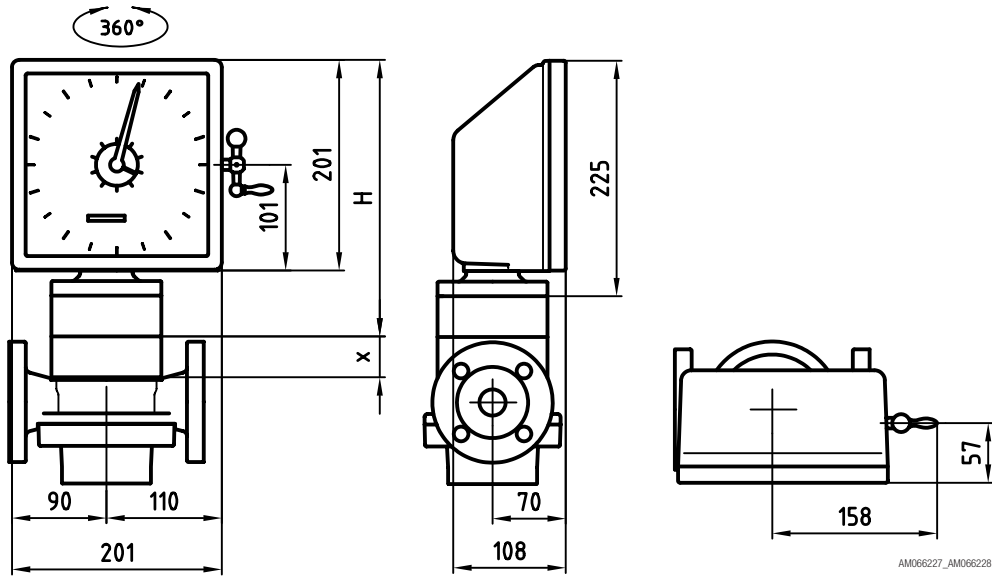

AM066227_AM066228

Type	Height (H) in mm
AS 110, 120	227
AS 111	266
AS 121, 122	266
AS 131, 132, 133	266

Dials

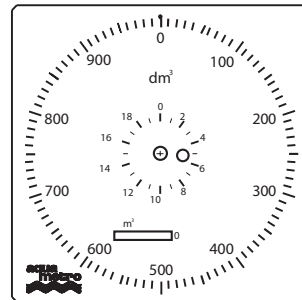
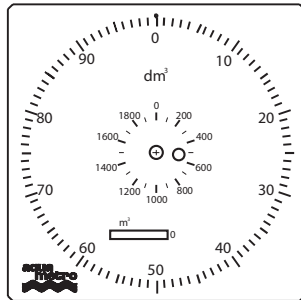
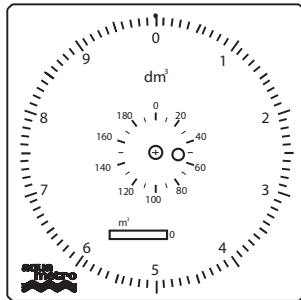

ASP filling controllers

Technical data



- Semi-automated filling control
- Preselect desired filling quantity on scale.
- The trailing pointer always shows the current filling quantity or preselected quantity.
- Press the start button to initiate filling. the valve opens. When the preset quantity is reached, the valve automatically closes again.
- The entire filling quantity is recorded on a roll-type meter which cannot be reset.
- Shutdown time can be adjusted to compensate for valve switching time.

Operating principle

Before starting the filling procedure, set the pointer and dial to the required filling quantity by turning the adjusting knob on the side of the controller clockwise. Press the start button to open the valve pneumatically. During filling, the black pointer turns back toward zero. When it reaches zero, filling is stopped automatically by closing the valve and the red pointer remains on the preset filling quantity. The stop button is only for use in emergencies.

The unit is fitted with an operating mode display and connections for an overflow prevention system. The pneumatic air supply can be branched with a T-piece for operating an external pressure transducer.

Scale type	ASP	21x	22x	23x	24x	25x	26x	27x
Temperature of medium inside meter	°C max.	180	180	180	180	180	180	180
Protection class		IP 65	IP 65	IP 65	IP 65	IP 65	IP 65	IP 65
Display scale								
Filling quantity max.	l	100	200	500	1000	2000	5000	10000
Filling quantity min. ¹⁾	l	25	50	125	250	500	1250	2500
Quantity per turn of pointer	l	100	200	500	1000	2000	5000	10000
Smallest readable quantity	l	1	2	5	10	20	50	100
Roller counter totalizer								
Registration capacity	Mio. m ³	0.1	0.1	1	1	1	10	10
Smallest readable quantity	m ³	0.01	0.01	0.1	0.1	0.1	1	1
Weight	kg	3.85	3.85	3.85	3.85	3.85	3.85	3.85
Compressed air								
Pneumatic operating pressure	bar	2...6	2...6	2...6	2...6	2...6	2...6	2...6

¹⁾ Measuring tolerance is about 0.5 % of scale graduation due to mechanical clearances. For small quantities the percentage error is slightly larger. Minimum filling quantity therefore depends entirely on desired filling precision. The values shown are recommended data.

Combination with DOMINO flowmeters

Version	Filling quantity up to ... litres	Flowmeter (type and nominal bore)										
		ARD			AMD		PMD					
		15	20	25	40	50	25	40	20	25	32	40
ASP 211	100	—	—	●	●	—	●	●	●	●	●	●
ASP 212	100	●	●	—	—	—	—	—	—	—	—	—
ASP 221	200	—	—	●	●	—	●	●	●	●	●	●
ASP 222	200	●	●	—	—	—	—	—	—	—	—	—
ASP 231	500	—	—	—	—	●	—	—	—	—	—	—
ASP 232	500	—	—	●	●	—	●	●	●	●	●	●
ASP 233	500	●	●	—	—	—	—	—	—	—	—	—
ASP 241	1000	—	—	—	—	●	—	—	—	—	—	—
ASP 242	1000	—	—	●	●	—	●	●	●	●	●	●
ASP 243	1000	●	●	—	—	—	—	—	—	—	—	—
ASP 251	2000	—	—	—	—	●	—	—	—	—	—	—
ASP 252	2000	—	—	●	●	—	●	●	●	●	●	●
ASP 253	2000	●	●	—	—	—	—	—	—	—	—	—
ASP 262	5 m ³	—	—	—	—	●	—	—	—	—	—	—
ASP 263	5 m ³	—	—	●	●	—	●	●	●	●	●	●
ASP 272	10 m ³	—	—	—	—	●	—	—	—	—	—	—
ASP 273	10 m ³	—	—	●	●	—	●	●	●	●	●	●

Dimensions

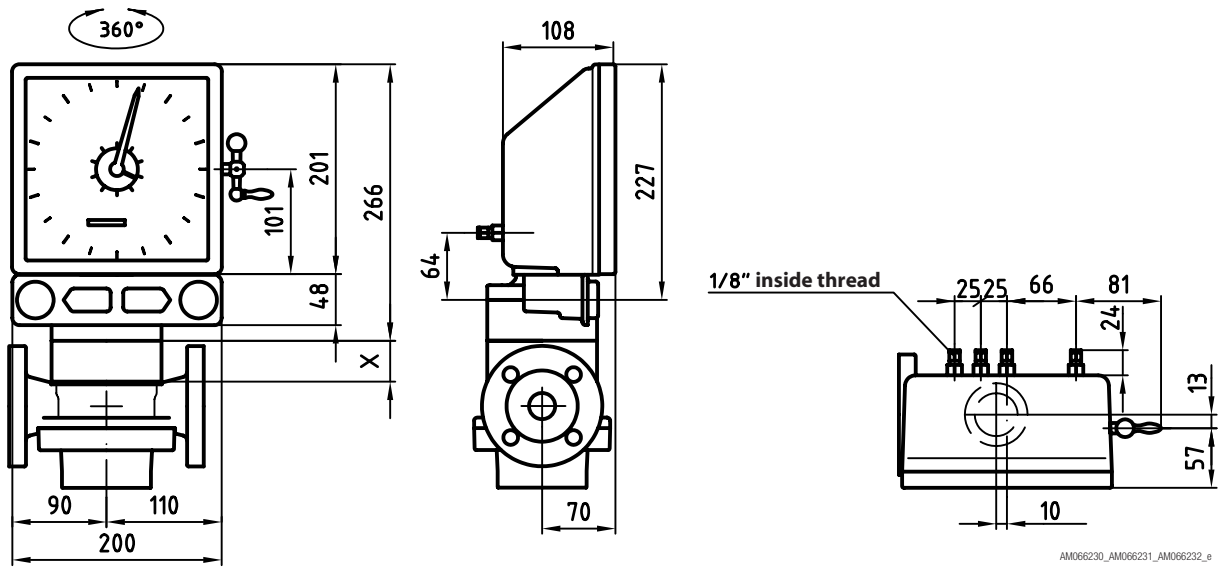

Wiring diagram

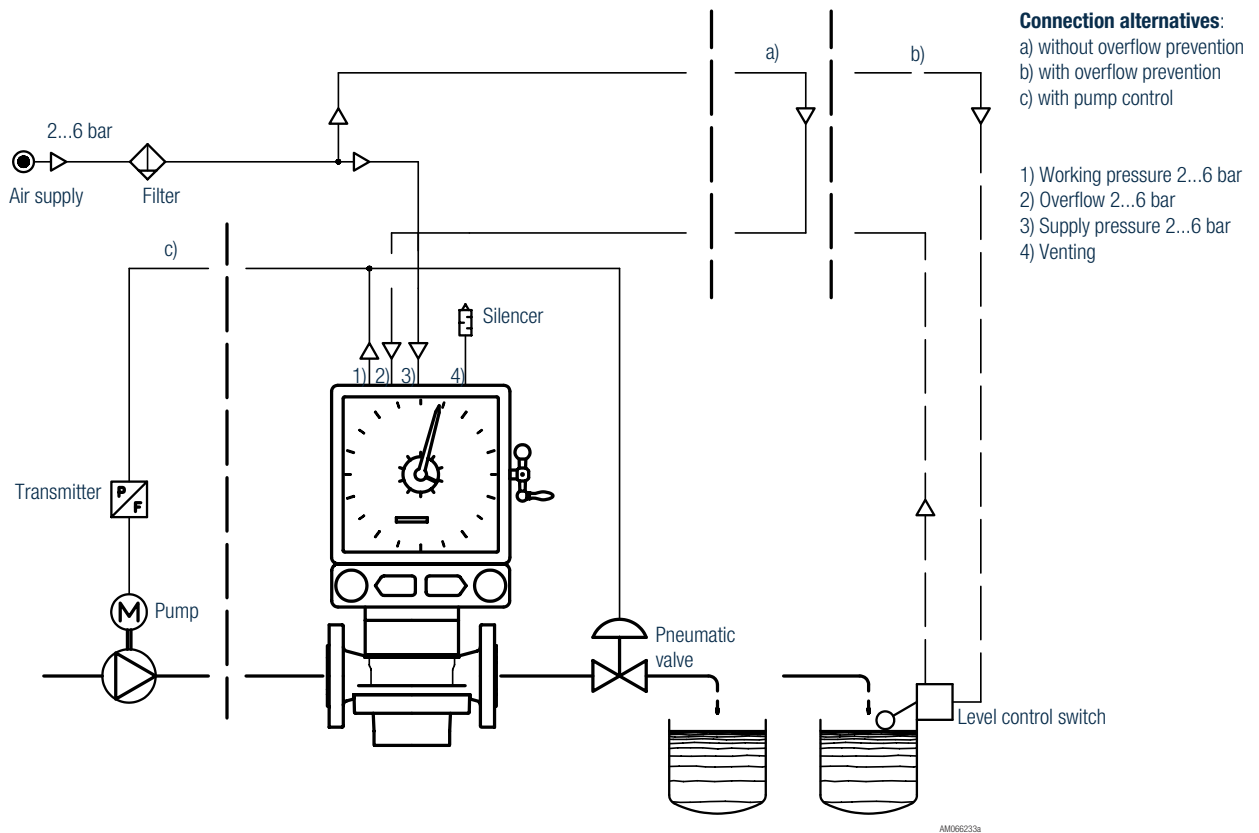

Serto Type So 21-6-1/8

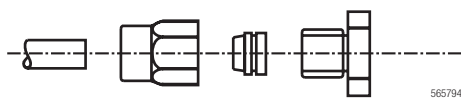

Dials

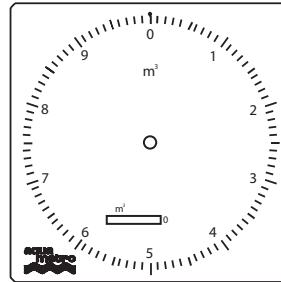
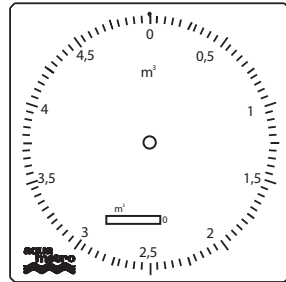
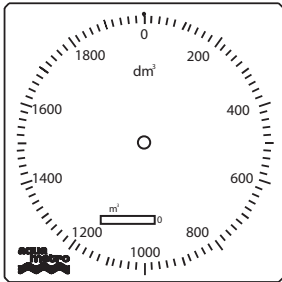
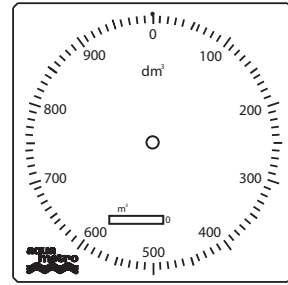
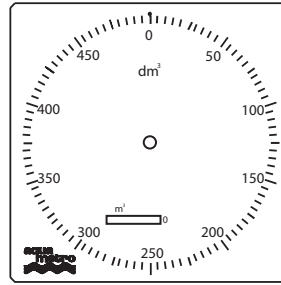
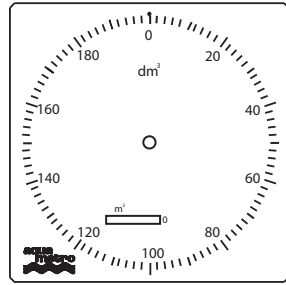
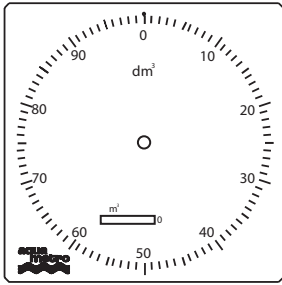

AN06022540

System planning

General

All flowmeters fitted with dosage dials are to be installed in horizontal pipes with the dial perpendicular to the pipe axis. The flowmeter is defined according to the prescriptions issued for industrial meters.

Manual filling/dosing

Manual valve (explosion-risk zones or non explosion-risk zones)

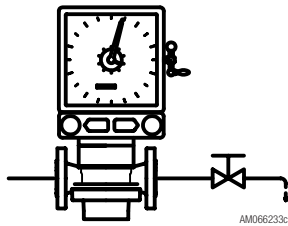

Half automatic filling/dosing (pneumatic control)

Pneumatic valve (explosion-risk zones or non explosion-risk zones)

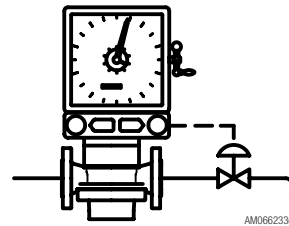

Hazardous areas

The dosage dials AS and ASP are also available for the use in hazardous areas.

Pneumatic feeding

For dial ASP use only dry, oil-free air (instrument air). If necessary, add a lubricator, after the ASP for operating the valve.

Installation

Dosage dial AS

The dial must be well readable from the manual valve and easily accessible for zero-reset.

Dosage dial ASP

The preselection knob and the start and stop buttons must be easily accessible. The dosage unit is to be installed in such a way that the stop button can easily be pushed in case of emergency.

Supply

Control pressure 1.2...1.4 bar, oil-free

Operation pressure 2...6 bar

Ancillary units

Valves must be mounted after the flowmeter, according to the prescriptions of their supplier.

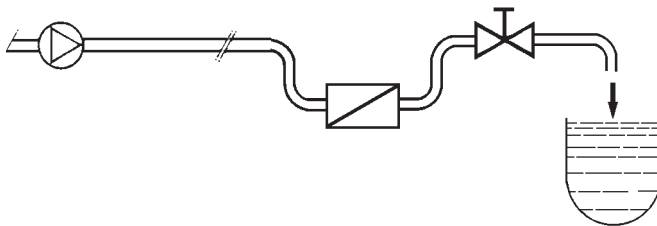

Ordering data

The following has to be considered when selecting a filling controller:

- a) Type and nominal bore of flowmeter
- b) Maximum filling quantity

Type designation	Version	Order No.
Filling control AS:		
AS 110	max. 200 l	83927
AS 111	max. 200 l	83928
AS 120	max. 2000 l	83929
AS 121	max. 2000 l	83930
AS 122	max. 2000 l	83931
AS 131	max. 20000 l	83932
AS 132	max. 20000 l	83933
AS 133	max. 20000 l	83934
Filling control ASP:		
ASP 211	max. 100	83935
ASP 212	max. 100	83936
ASP 221	max. 200	83937
ASP 222	max. 200	83938
ASP 231	max. 500	83939
ASP 232	max. 500	83940
ASP 233	max. 500	83941
ASP 241	max. 1000	83942
ASP 242	max. 1000	83943
ASP 243	max. 1000	83944
ASP 251	max. 2000	83945
ASP 252	max. 2000	83946
ASP 253	max. 2000	83947
ASP 262	max. 5 m ³	83948
ASP 263	max. 5 m ³	83949
ASP 272	max. 10 m ³	83950
ASP 273	max. 10 m ³	83951
With EC-Type-Examination Certificate Ex II 2G c T6		96045

SWITZERLAND: Aquametro Oil & Marine AG, Therwil
CHINA: Aquametro Oil & Marine (CHINA) PTE. LTD., Singapore
GERMANY: Aquametro Oil & Marine GmbH, Rostock
INDIA: Aquametro Oil & Marine Rep. Office, Mumbai
JAPAN: Aquametro Oil & Marine Rep. Office, Tokyo
KOREA: Aquametro Oil & Marine Korea LTD., Busan
SINGAPORE: Aquametro Oil & Marine (S.E.A.) PTE. LTD., Singapore
UAE: Aquametro ME JLT, Dubai / UAE

info@aquametro-oil-marine.com **www.aquametro-oil-marine.com**
 info@aquametro-oil-marine.cn **www.aquametro-oil-marine.cn**
 info@aquametro-oil-marine.de **www.aquametro-oil-marine.de**
 info@aquametro-oil-marine.in **www.aquametro-oil-marine.in**
 info@aquametro-oil-marine.jp **www.aquametro-oil-marine.jp**
 info@aquametro-oil-marine.kr **www.aquametro-oil-marine.kr**
 info@aquametro-oil-marine.sg **www.aquametro-oil-marine.sg**
 info@aquametro-oil-marine.ae **www.aquametro-oil-marine.ae**